

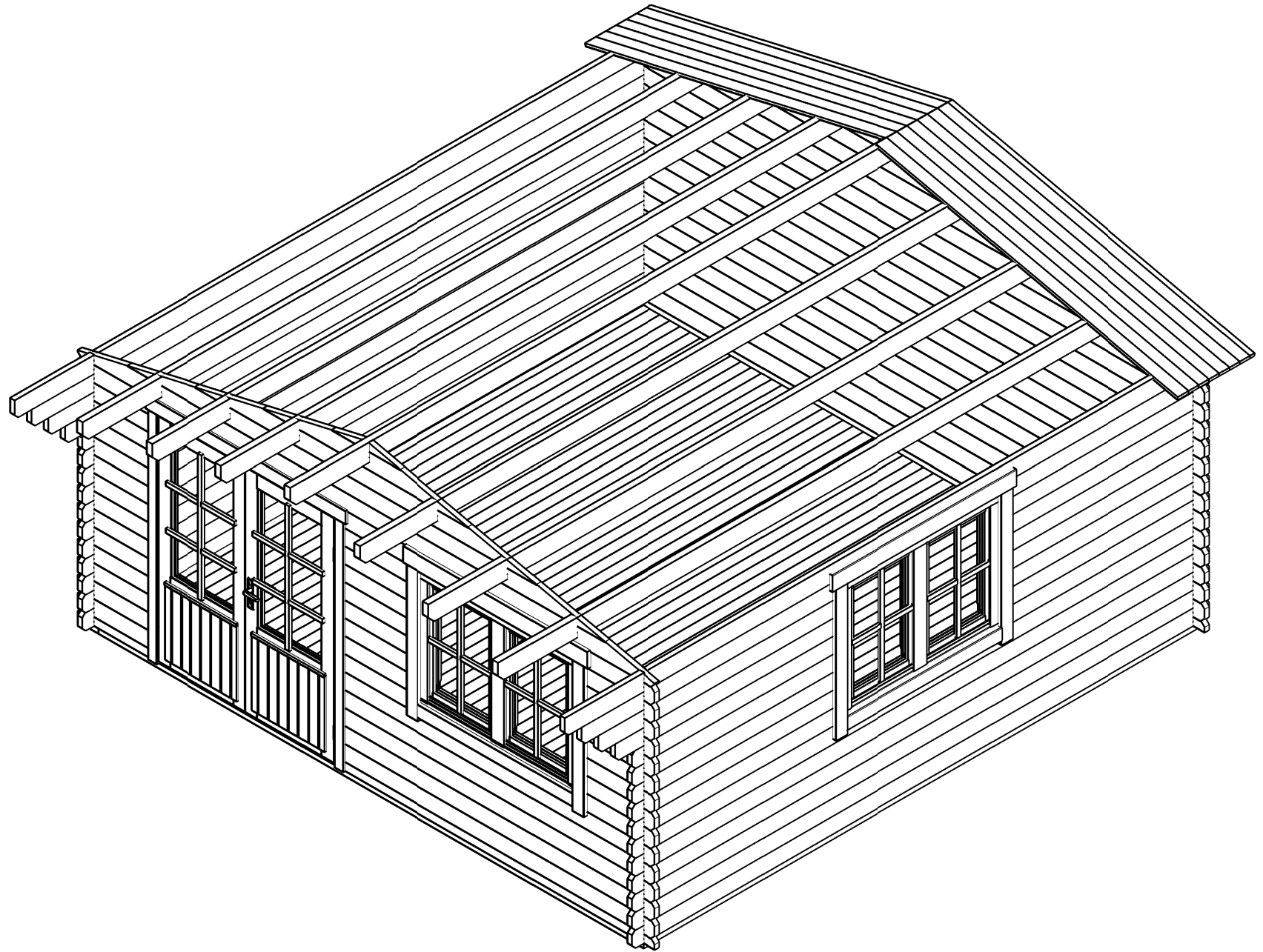

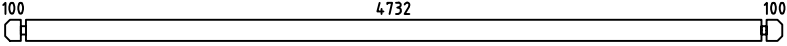

# Lillian 34 5x5

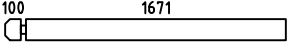
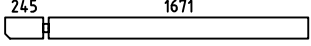
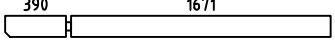
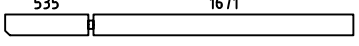
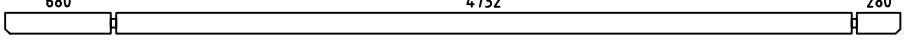
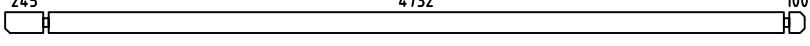
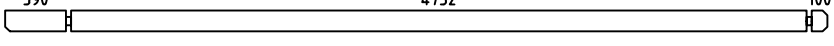
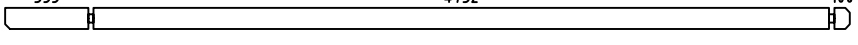
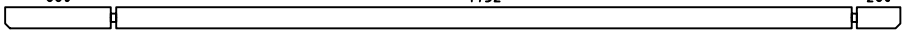
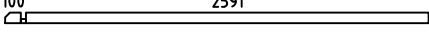
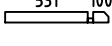
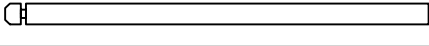

| Pos  | Specification-Spezifikation-Specificatie-Nomenclature-Elementi-Especificacion<br>Lillian 34 5x5  | Qty      | Profile<br>(mm)     | Lenght<br>(mm) |
|------|--|----------|---------------------|----------------|
| 001  |    | 31       | 34x135              | 5000           |
| 002  |   | 13       | 34x135              | 1805           |
| 003  |   | 1        | 34x135              | 1950           |
| 004  |   | 1        | 34x135              | 2095           |
| 005  |   | 1        | 34x135              | 2240           |
| 006  |    | 1        | 34x135              | 5760           |
| 007  |    | 1        | 34x135              | 5145           |
| 008  |    | 1        | 34x135              | 5290           |
| 009  |    | 1        | 34x135              | 5435           |
| 010  |   | 1        | 34x135              | 5760           |
| 011  |   | 1        | 34x68               | 2725           |
| 012  |   | 1        | 34x68               | 665            |
| 013  |   | 6        | 34x135              | 2725           |
| 014  |   | 22       | 34x135              | 665            |
| 015  |   | 8        | 34x135              | 665            |
| 021  |    | 1        | 34x68               | 5000           |
| WA-1 |    | 1        |                     |                |
| WB-1 |    | 1        |                     |                |
| F2   | FOUNDATION-FUNDAMENT-FONDATION-FONDAZIONE-VIGAS DE CIMENTACIÓN<br> | 2        | 70x44               | 4790           |
| F1   | FOUNDATION-FUNDAMENT-FONDATION-FONDAZIONE-VIGAS DE CIMENTACIÓN<br> | 10       | 70x44               | 4650           |
| PL1  | PURLIN-DAKBALK-DACHPFETTE-PANNE-ARCARECCIO-CORREA<br>              | 6        | 44x144              | 5760           |
| Kood | Lillian 34 5x5   | Materjal | File Lillian 34 5x5 | Leht 1/3       |

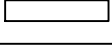
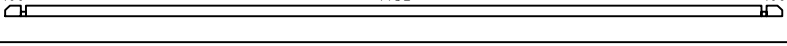
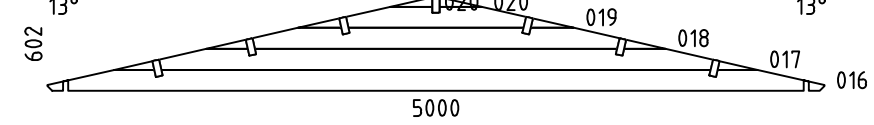
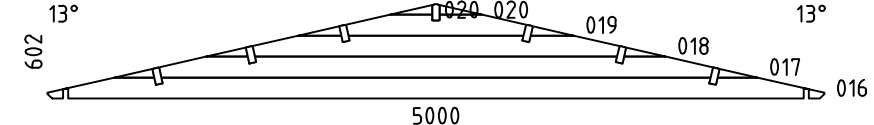
| Pos    | Specification-Spezifikation-Specificatie-Nomenclature-Elementi-Especificacion<br>Lillian 34 5x5                            | Qty          | Profile<br>(mm) | Lenght<br>(mm) |
|--------|--|--------------|-----------------|----------------|
| PL2    | PURLIN-DAKBALK-DACHPFETTE-PANNE-ARCARECCIO-CORREA<br>680<br>4732<br>280  | 1            | 44x144          | 5760           |
| F-1    | Floor board-Fussbodenbrett-Vloerplank-Lame de plancher-Tavola pavimento-Tabla de suelo                                     | 54+1<br>42+1 | 88x18<br>114x18 | 4722           |
| R-1    | Roof board-Dachbrett-Dakplank-Volige-Tavola tetto-Tabla de tejado  | 132<br>102   | 88x18<br>114x18 | 2675           |
| FLB-1  | Floor beading 2000-Fussbodenleiste-Plinten-Moulure de finition-Listello pavimento-Liston de suelo                          | 10           | 18x40           | 20rmt.         |
| GB-1   | Gable board 95-Giebelblende-Gevelplank-Planche de rive-Tavola di bordo-Tabla de borde                                      | 4            | 18x95           | 2880           |
| GB-1   | Gable board 120-Giebelblende-Gevelplank-Planche de rive-Tavola di bordo-Tabla de borde                                     | 4            | 18x120          | 2715           |
| RL-1   | Roofing lath 3000-Giebelleiste-Gevellijst-Latte de rive-Listello di bordo-Listones de borde                                | 8            | 18x40           | 24rmt.         |
| SS-1   | Storm slat kit-Sturmleiste satz-Stormanker set-Kit de latte anti tempête-Kit listello di tempesta-Kit liston anti tormenta | 4            | 18x40           | 2000           |
| D      | Diamond  | 2            |                 |                |
|        | Double door kit-Doppeltür satz-Dubbele deur set-Kit double porte-Kit porta-Kit para puerta                                 | 1            |                 |                |
|        | Nail 1.6x30-Nagel-Spijker-Clou-Chiodo-Clavo  | 30           | 1.6x30          |                |
|        | Nail 1.8x40-Nagel-Spijker-Clou-Chiodo-Clavo  | 1350         | 1.8x40          |                |
| S4x60  | Screw 4x60-Schraube-Schroef-Vis-Vite-Tornillo  | 70           | 4x60            |                |
| S6x120 | Screw 6x120-Schraube-Schroef-Vis-Vite-Tornillo   | 40           | 6x120           |                |
|        | Window handle set-Fenstergriff-Raamgreep-Ferrure de fenêtre-Ferramenta finestra-Manilla ventana                            | 4            |                 |                |
|        | WINDOW 1380x1050<br>DW0-4DK 138x105-34   | 2            |                 |                |
|        |  |              |                 |                |
|        |  |              |                 |                |
|        |  |              |                 |                |
| Kood   | Lillian 34 5x5   | Materjal     | File            | Lillian 34 5x5 |
|        |  |              | Leht            | 2/3            |

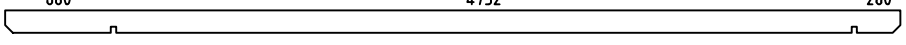

H = 1.200 m  
 TOTAL: 22.39 m<sup>2</sup>

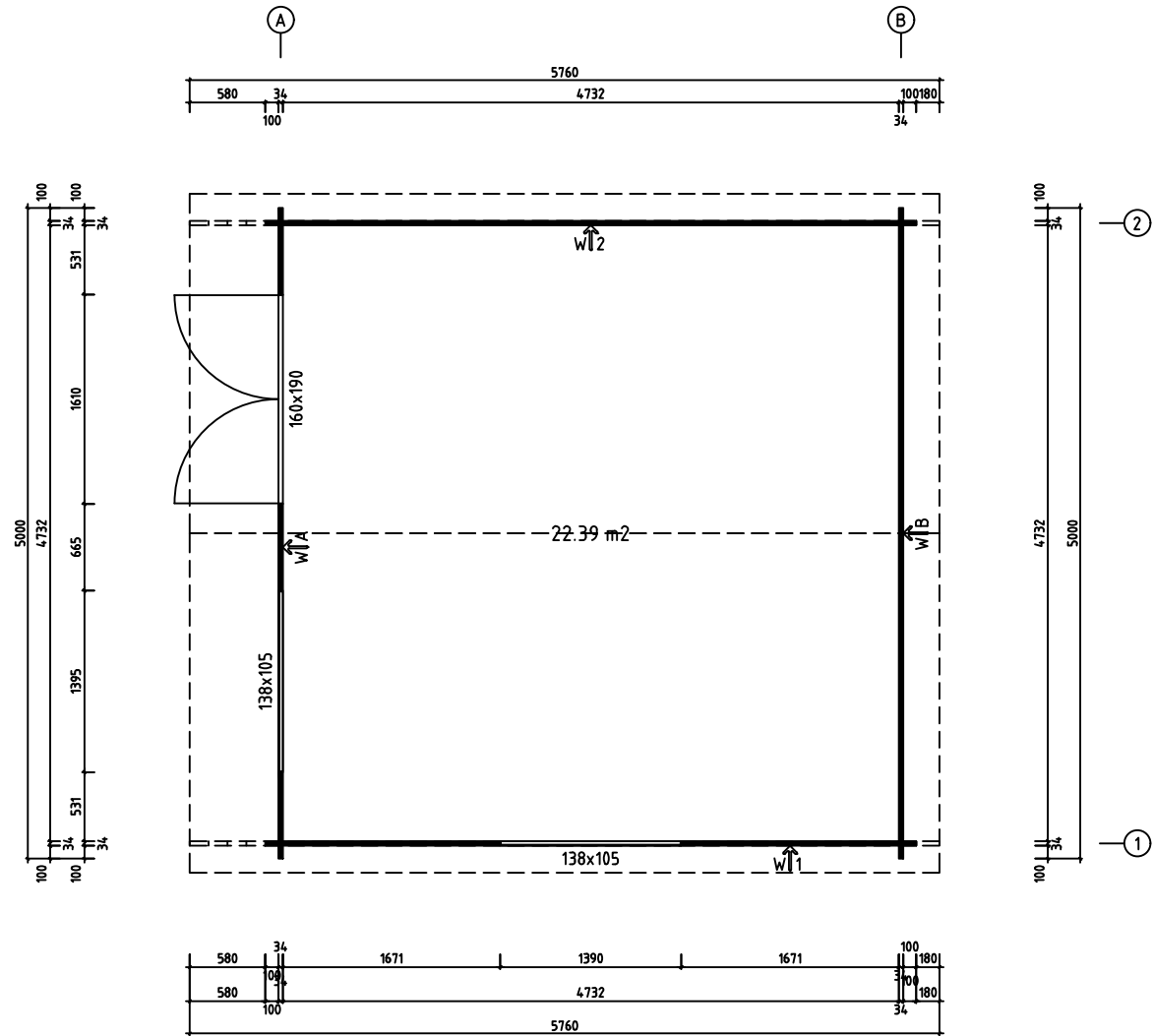

|          |                |                 |
|----------|----------------|-----------------|
|          |                |                 |
| Model    | Lillian 34 5x5 | Page            |
| Drawing  | PLAN           | Scale 1:4.0     |
| Material | 34x135         | Date 13.02.2026 |
| File     | Lillian 34 5x5 | Drawn by        |

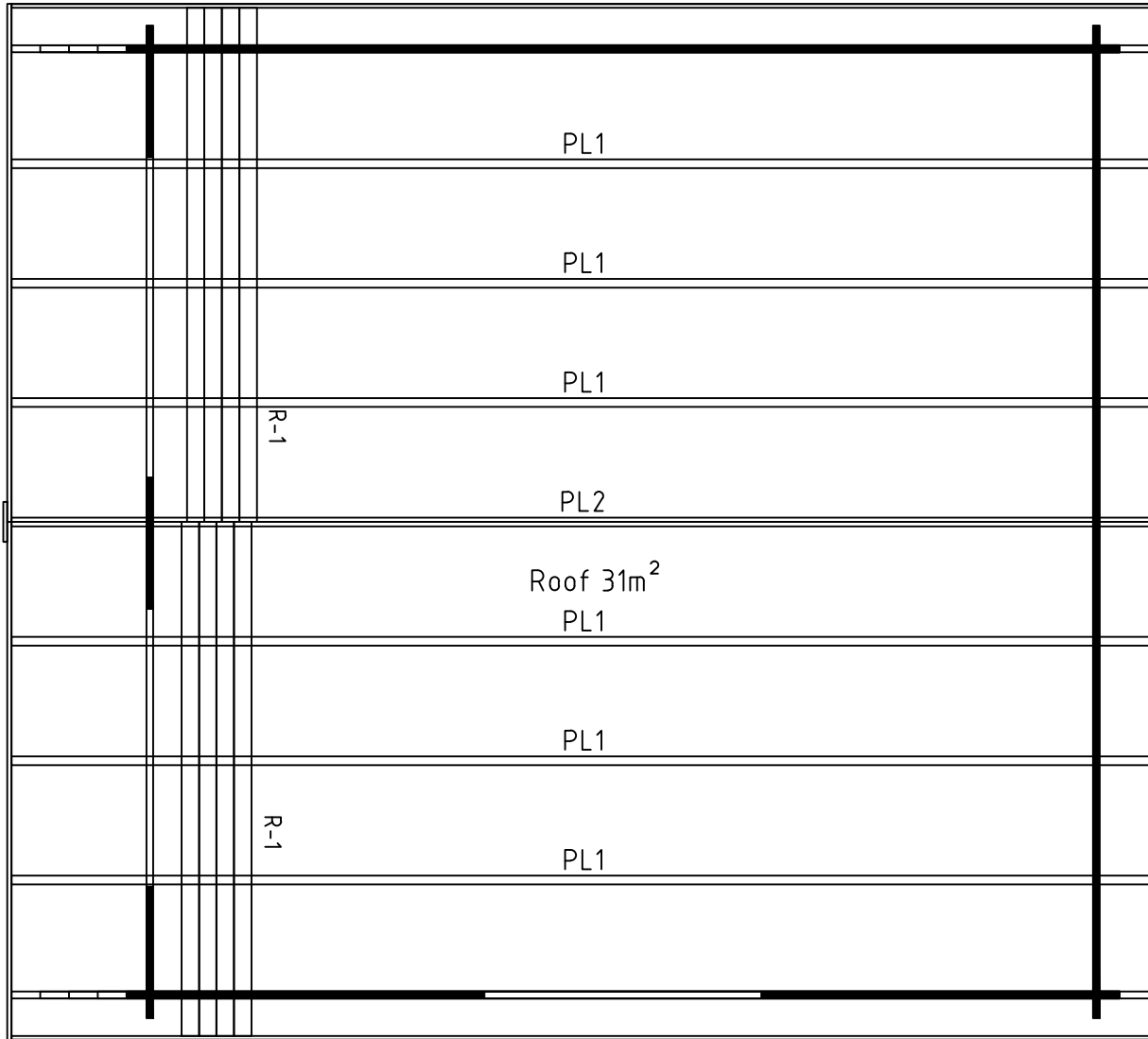

0 0.5m 1.0m 2.0m

|          |                |                 |
|----------|----------------|-----------------|
| Model    | Lillian 34 5x5 | Page            |
| Drawing  | ROOF           | Scale 1:40      |
| Material | 34x135         | Date 13.02.2026 |
| File     | Lillian 34 5x5 | Drawn by        |

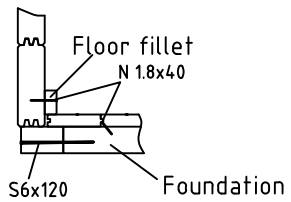
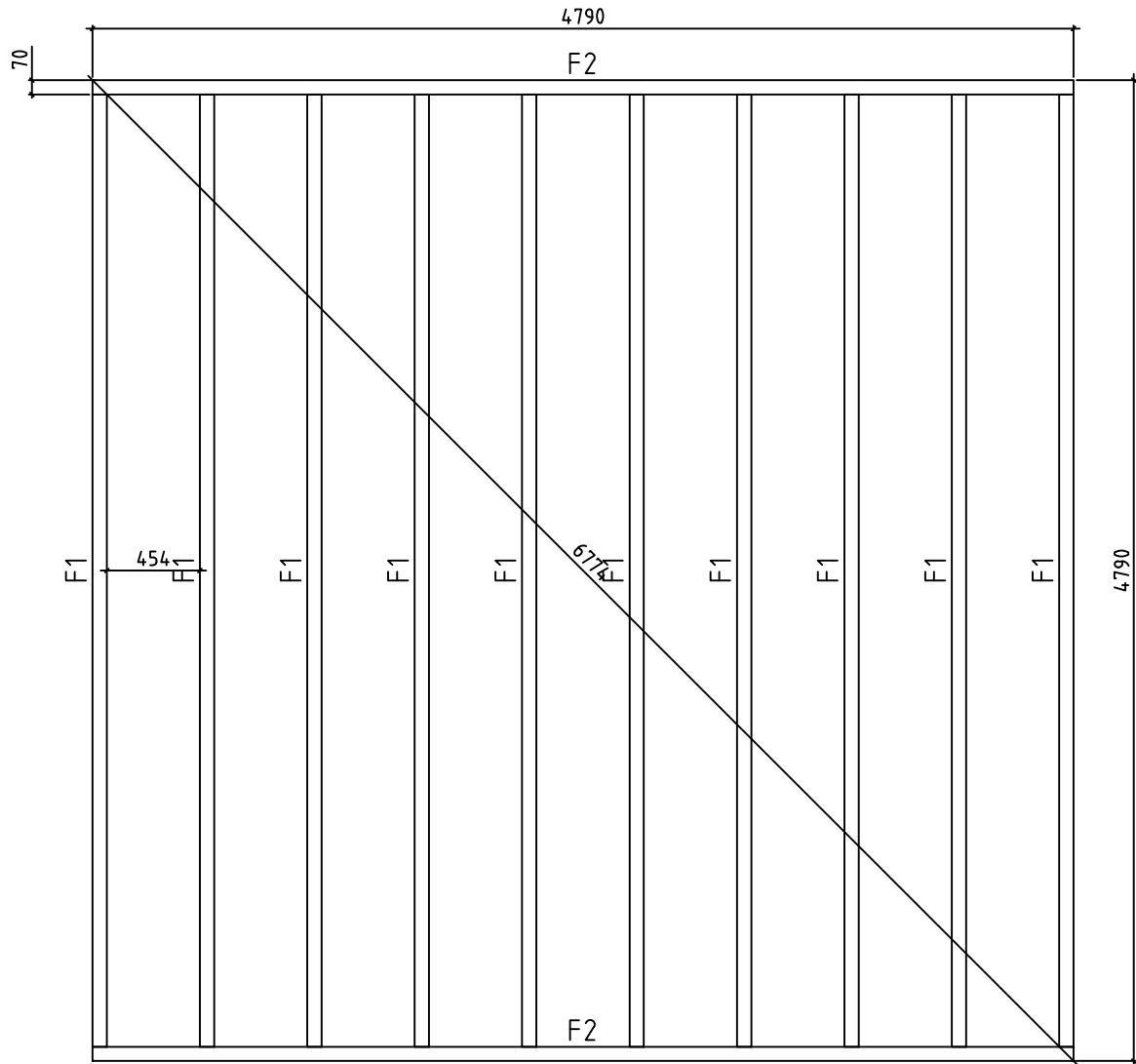

|          |                |                 |
|----------|----------------|-----------------|
| Model    | Lillian 34 5x5 | Page            |
| Drawing  | FOUNDATION     | Scale 1:40      |
| Material | 34x135         | Date 13.02.2026 |
| File     | Lillian 34 5x5 | Drawn by        |





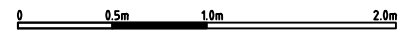
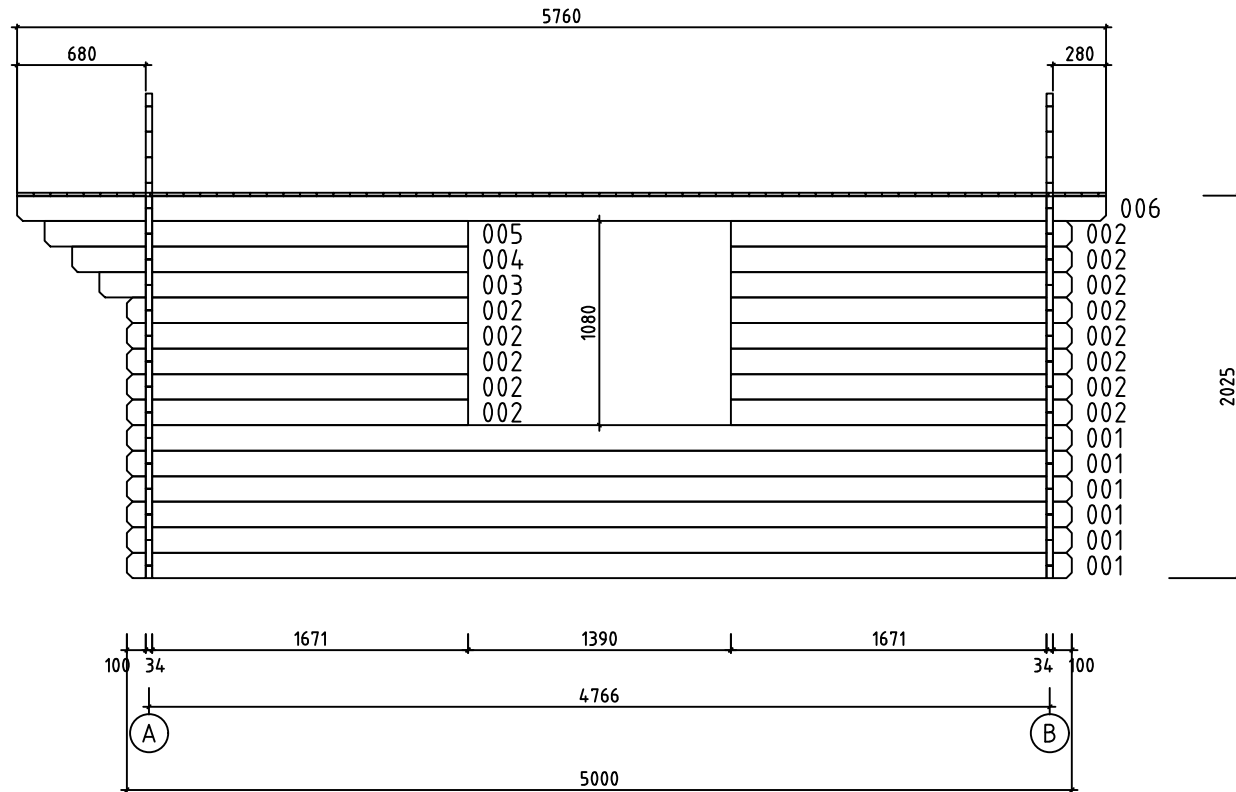
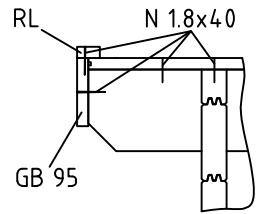

|          |                |          |            |
|----------|----------------|----------|------------|
| Model    | Lillian 34 5x5 | Page     | 4          |
| Drawing  | WALL 1         | Scale    | 1:40       |
| Material | 3.4x13.5       | Date     | 13.02.2026 |
| File     | Lillian 34 5x5 | Drawn by |            |

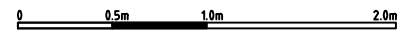
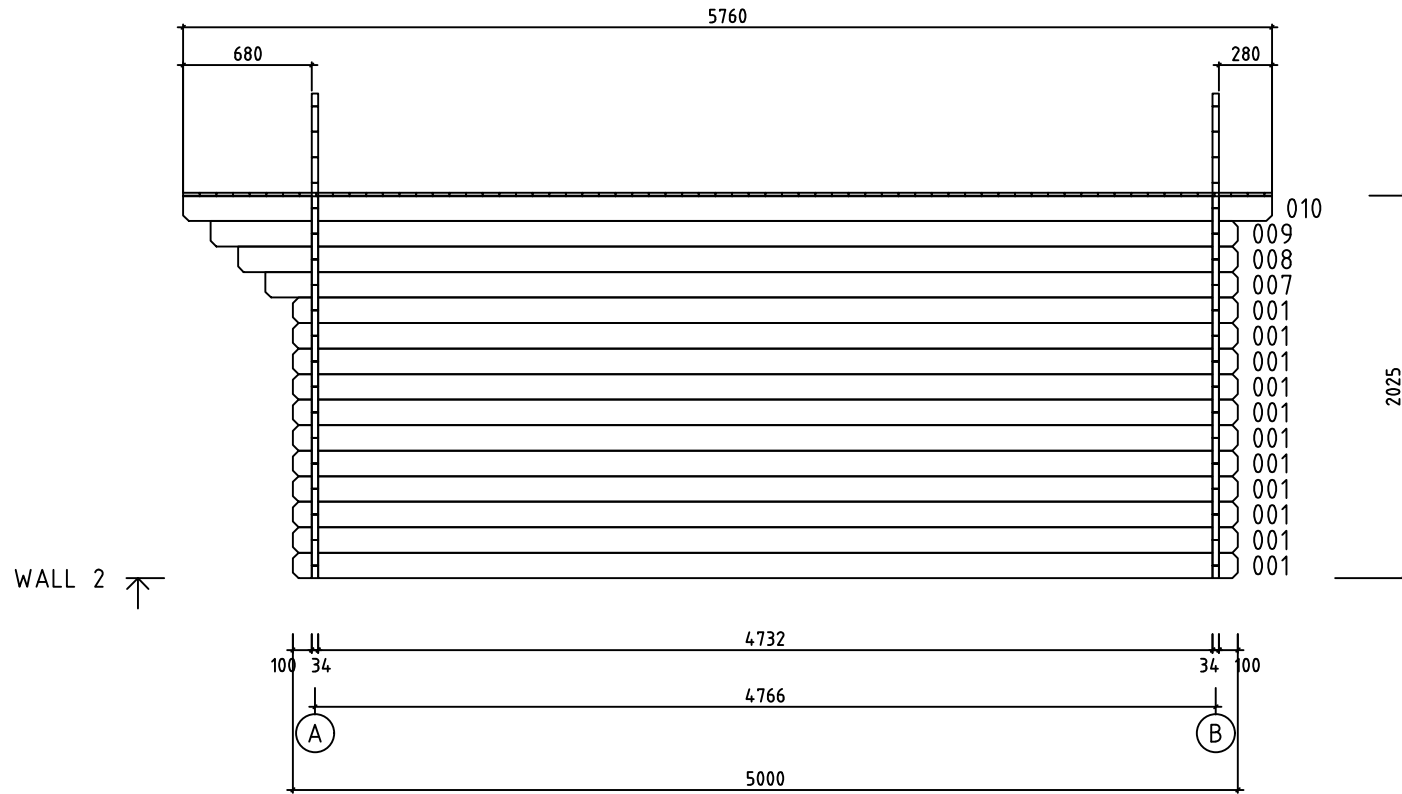

|          |                |          |            |
|----------|----------------|----------|------------|
| Model    | Lillian 34 5x5 | Page     | 5          |
| Drawing  | WALL 2         | Scale    | 1:40       |
| Material | 3.4x13.5       | Date     | 13.02.2026 |
| File     | Lillian 34 5x5 | Drawn by |            |

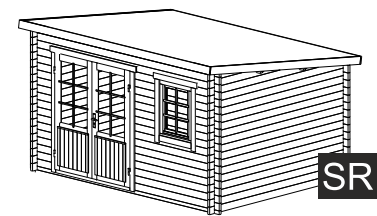
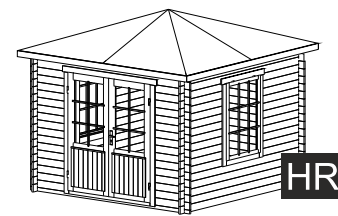
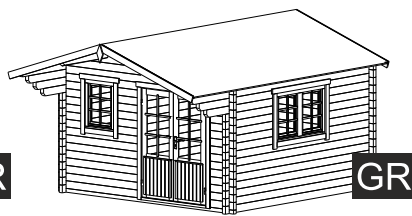
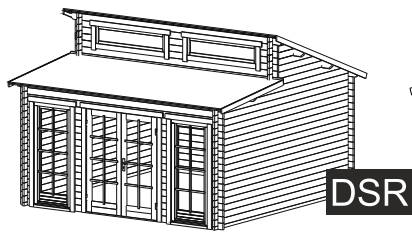
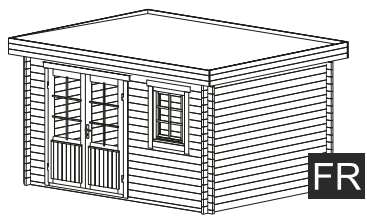

FR

DSR

GR

HR

SR

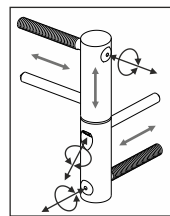
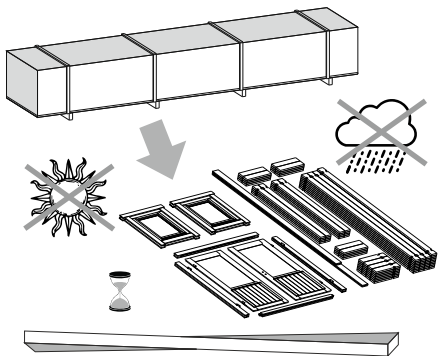

ADJUSTABLE HINGES

3.

TYPE-A  
5x90

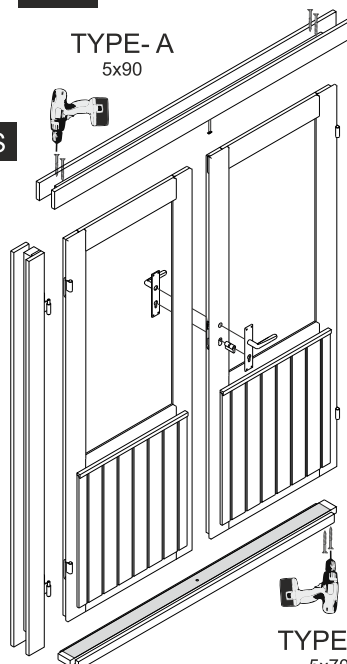

OPTIONS

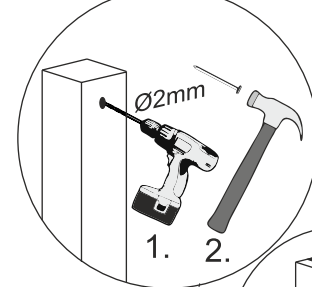

1. 2.

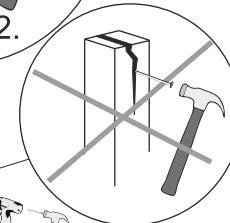

4.

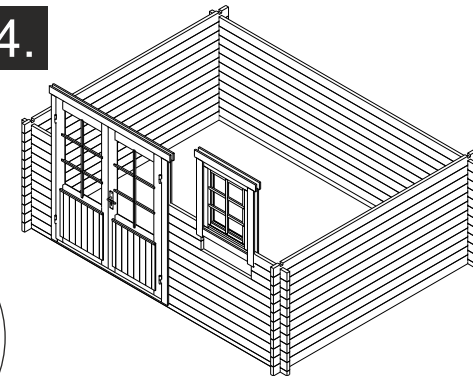

OPTIONS

1.

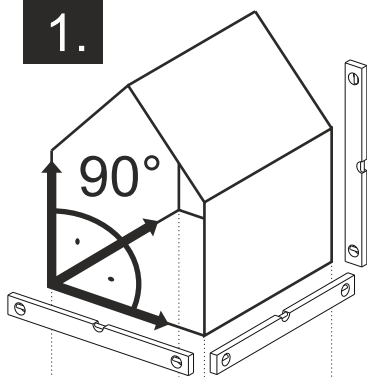

5.

Ø4mm

Ø4mm

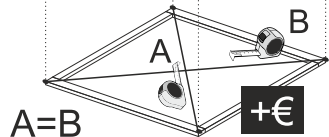
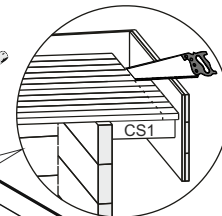

+€

NB!

TYPE-A  
5x70

OPTIONS

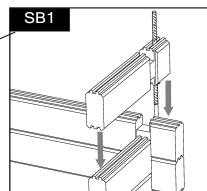

FR

2.

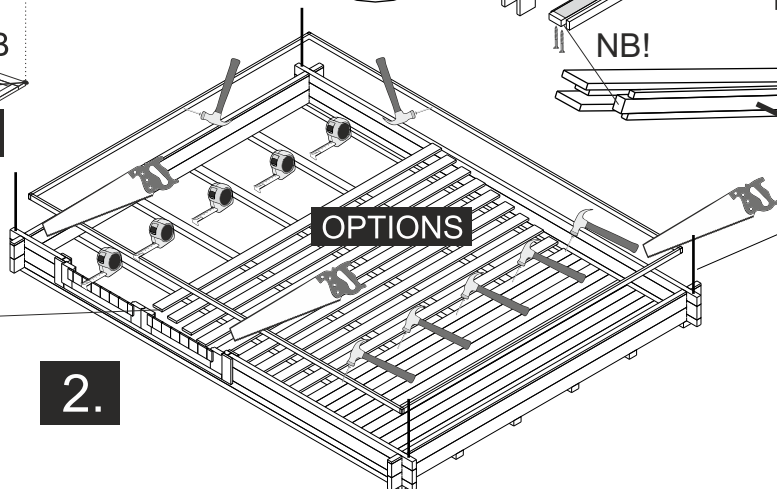

OPTIONS

The guide is illustrative. This guide is not project specification.  
Der Leitfaden ist illustrativ. Dieser Leitfaden ist keine Projektspezifikation.  
De gids is illustratief. Deze gids is geen projectspecificatie.

5.

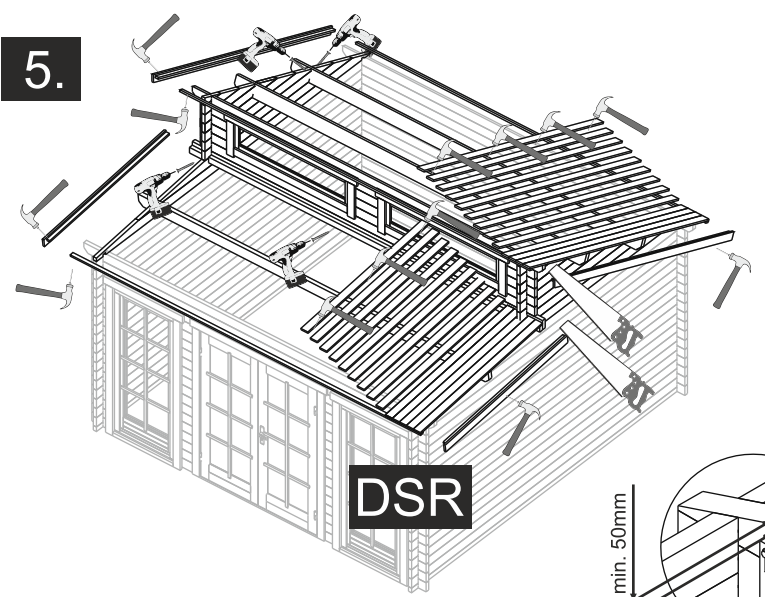

**DSR**

5.

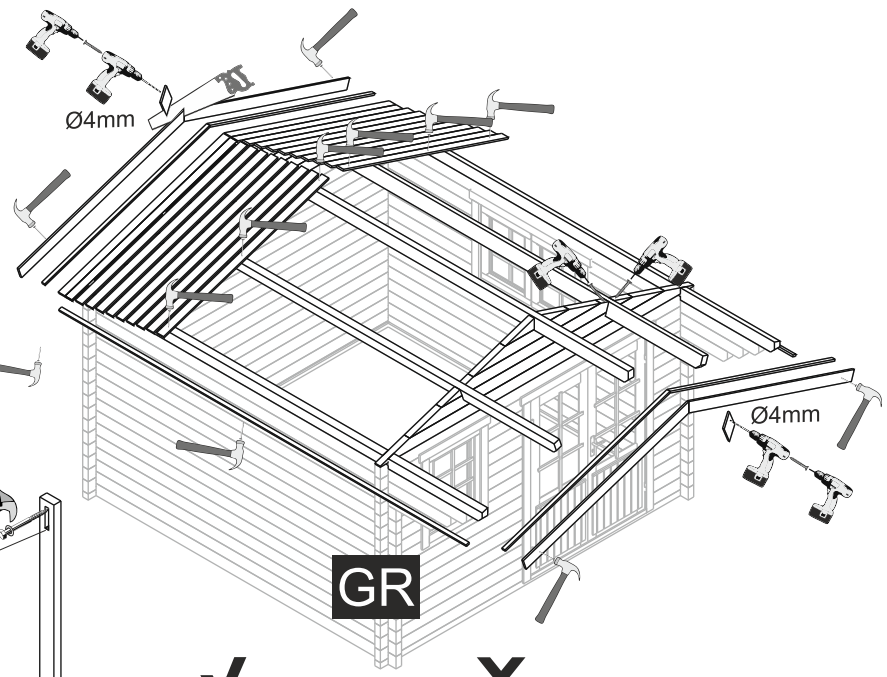

**GR**

**OPTIONS**

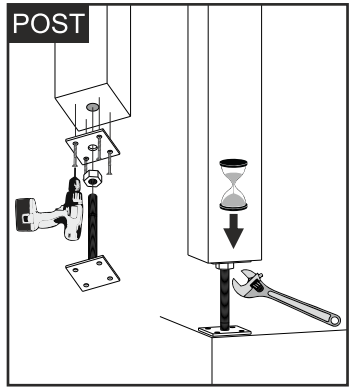
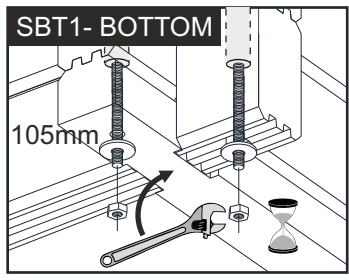
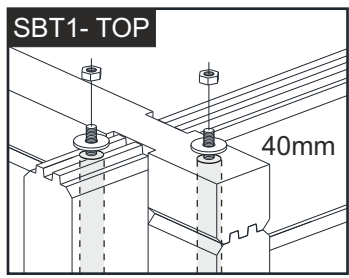
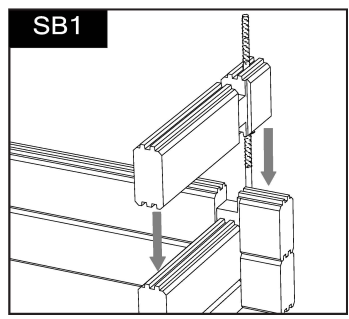

**NB!**

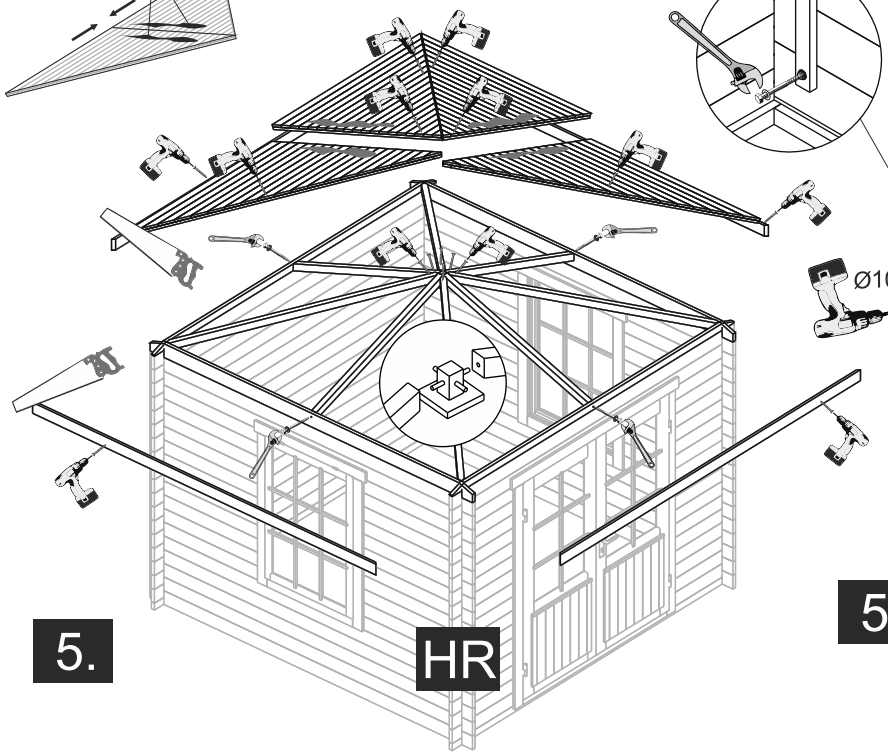

**HR**

5.

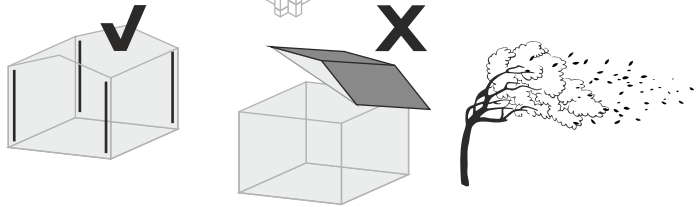

**OPTIONS-STORM BRACES**

5.

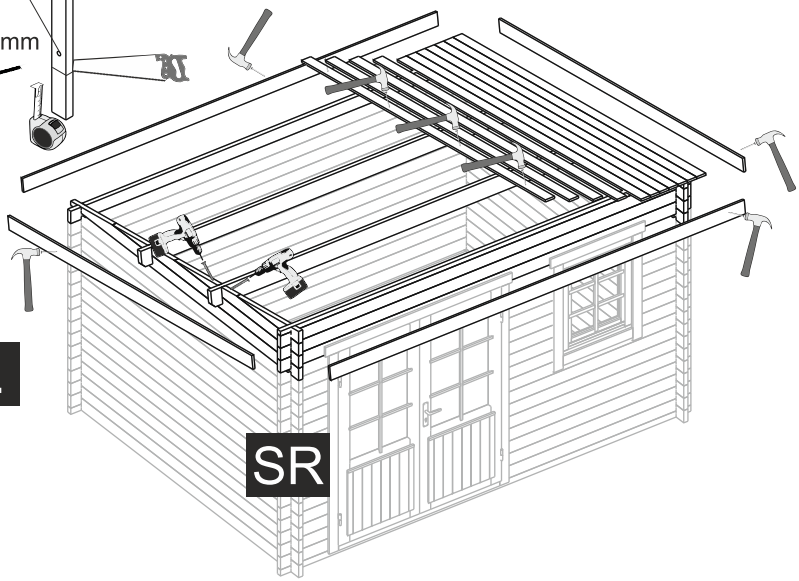

**SR**

Öffnung/Opening

A

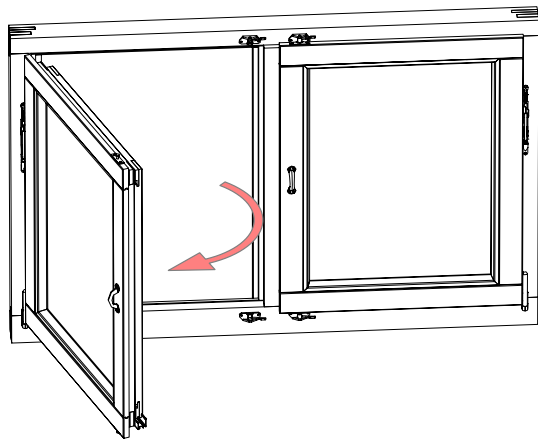
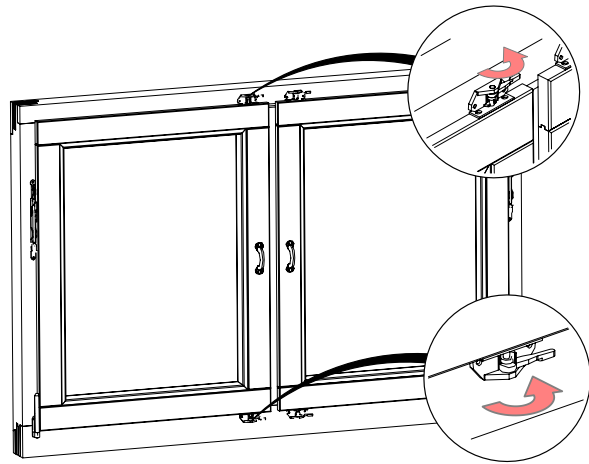

B

